

JREALITY

J7EF User's Guide



Jorjin Technologies Inc.
AR Smart Glasses

Appearance/Function Diagram

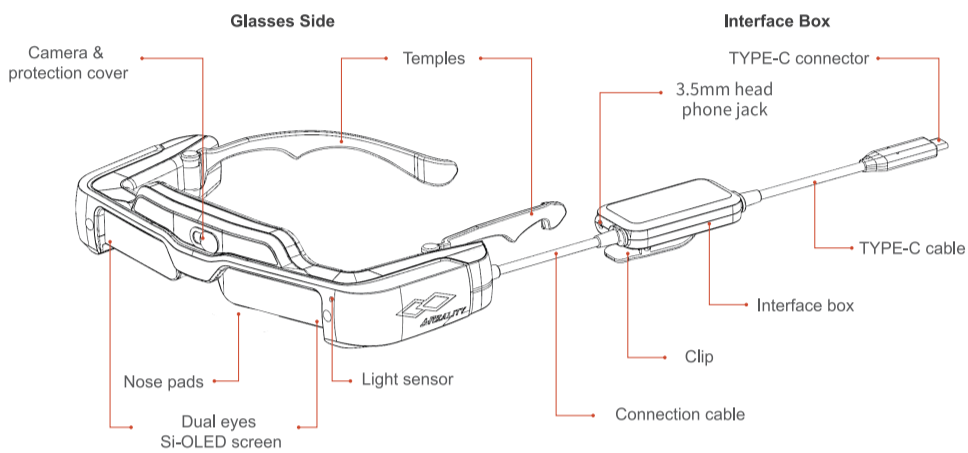

Included Items



Type C Power Cable Connection

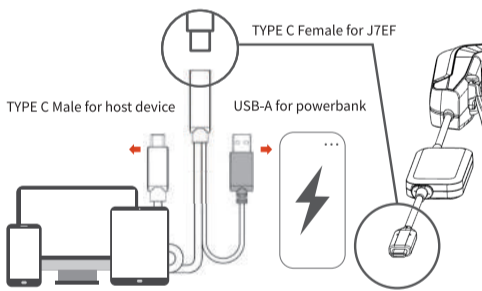

Calibrate the Magnetic Sensor

If the magnetic sensor is not operating correctly, wave the headset in a figure 8 shape while a smart device is connected to calibrate the sensor.

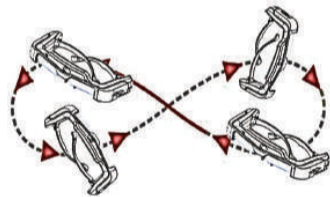

Function Control

• **J-Reality Control is an application for Android devices, suitable for the operation of AR smart glasses, including the following functions.**

- Display and adjust screen brightness and volume
- Allows switching between 2D and 3D modes, only support side by side in 3D mode.
- Allows to lock the screen of the smart device to prevent accidental operation.

• **The link below is supplementary information for functional operations:**

<https://www.jorjin.com/products/ar-smart-glasses/j-reality/j7ef/>



Camera Operating

- Download the Google Play app "USB Camera" to operate the camera on the AR smart glasses.
- If the camera of the smart device is active, please switch to USB camera mode.
- You can use Jorjin's JJSDK for Android application development. If you have any request, please contact Jorjin sales staff.

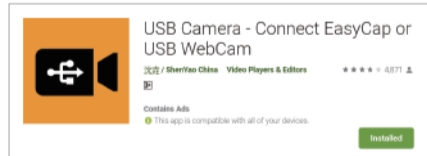

Visor

- When the environment is too bright, it may affect the viewing experience. You can solve this problem by attaching the shade supplied.
- Shade is magnetic and can be attached easily.

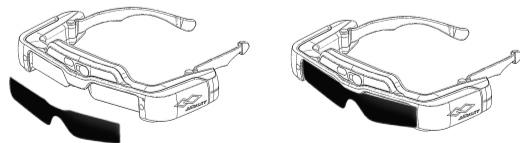

Lens Holder

- The lens holder is an additional accessory. Users can visit a general glasses store to consult an optician to install user's prescription lens. The cost of the prescription lenses must be borne by the customer.

| Insert glasses | |
|----------------|----------|
| Lens(W x H) | 54x24 mm |
| Nose width | 20 mm |
| Frame PD | 70 mm |
| Curve | 4 |

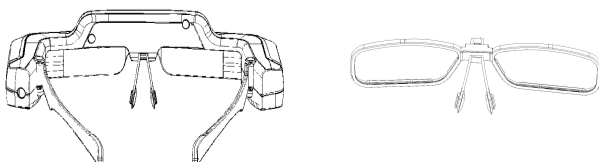

How To Wear

1. Hold both sides of the AR smart glasses and gently open the temples with your thumbs.
2. Open the temple tips about one centimeter each, and wear it from the forehead at a slight angle.
3. Push the AR smart glasses near the face until you see a clear image.

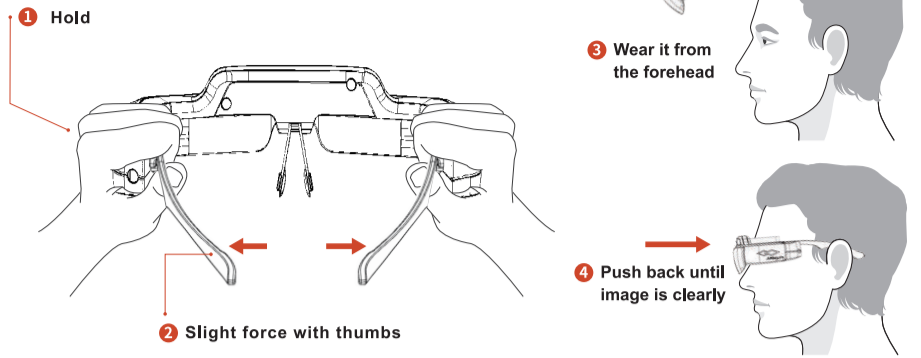

Connect Host Device

• **Connect the TYPE-C cable of the AR smart glasses to the host device.**

- Connect a host device that supports USB Type-C Display Port Alternate Mode.
- You need to use your own host device.
- This product is powered by the battery in your host device. Please make sure that the host device is fully charged before use.
- Be sure there is no casing or protective case of the host device which may block the USB Type-C port.
- We can't guarantee that your own USB adapter or conversion cable be supported.
- Make sure that the host device is turned on and not in sleep mode.
- You need to adjust the position of AR smart glasses after wearing them to make sure that you can see the image properly. Each person may have a viewing experience of its own.

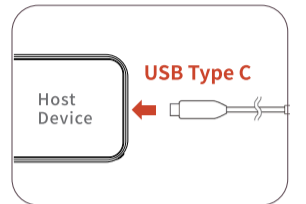

Connect To Headset

- Connect headset to the headphone jack of the interface box. We suggest to use a headset that is conform by CTIA standard.
- When using a 3-pole headset, the microphone will not function.
- If you need to connect/unplug the headset or the USB Type-C connector when playing content, please remove the headset first to avoid hearing the noise.
- Please use the volume keys on the smart device to adjust the volume.
- We cannot guarantee that any adapter will work properly.

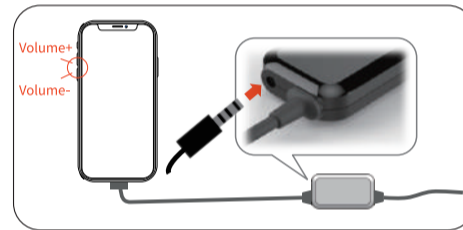

Video Control

- Connect a smart device that supports USB Type-C DisplayPort Alternate Mode, AR smart glasses will display the content of the screen of the smart device. Unplug the TYPE-C cable, AR smart glasses will stop displaying the screen.
- If you press the power button on the smart device after connection, the video and audio will stop working.
- Press the power button on the smart device again, and the video and audio will restart working.
- If you need to pause or stop the video, please operate the smart device.

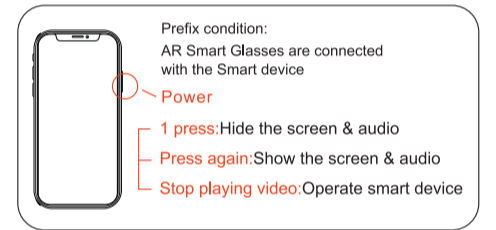

Specification

| | | | |
|---------------------------|----------------------|---|--|
| Optics | Material | Si-OLED | |
| | Panel size | 0.453" wide panel (16:9) | |
| | Resolution | 1920 x 1080 | |
| | Angle of view | Approximately 34 degrees (diagonally) | |
| | Virtual screen size | 120" support (virtual viewing distance 5m) | |
| Sensor | Color reproduction | 24bit color (approximately 16,770,000 colors) | |
| | Camera | 8 million pixels | |
| | Magnetic | Yes, 3 Axis sensor in smart glasses | |
| | Gyrometer | Yes, 3 Axis sensor in smart glasses | |
| | Acceleration sensor | Yes, 3 Axis sensor in smart glasses | |
| Audio | Ambient Light Sensor | Yes, 1- 65528 lux | |
| | Audio jack | 3.5 Φ 4 mini jack, CTIA type | |
| Video Input | USB Type-C | Video interface | DisplayPort Alternate Mode (DP Alt Mode) |
| | | EDID | Supported |
| Data Communication | | HDCP | Supported |
| | USB Type-C | USB protocol | USB 2.0 |
| | | Windows | Windows 10 or later |
| Power | | Android | Android 8 or later |
| | USB Type-C | USB Type-C @1.5A | |
| | | Power consumption | 6W |
| | | Rated input voltage/Current | 5.0V/1.2A |

| | | |
|---------------------------|-----------------------------------|---|
| Supported format | Supported 3D | Side-by-side format |
| | Headset Exterior dimensions | 200 x 182 x 55 mm (without the visor) |
| Common Information | Interface box Exterior dimensions | 60 x 31 x 20mm |
| | Weight- Headset | 127g +/-15g (exclude visor) |
| | Weight- Interface Box | 45g +/-5g (include cable) |
| | Cable Length | 109 cm +/- 1 cm (include Interface Box) |
| | Operating temperature | 5 to 35°C humidity 20 to 80% |
| | Storage temperature | -10 to 60°C humidity 20 to 80% |

* This product only applies to USB Type-C DisplayPort Alternate Mode, but not all mobile phones that meet this specification are compatible. Please refer to the Jorjin official website for compatible mobile phones.
* Please remove the protective film before using

• The visual impact point

The visual impact point is about 120 inches (diagonal) at five meters. Visual experience may differ person by person.

• 3D Vision Warning

Long periods of viewing 3D images may result in eye fatigue.
(1) take 10 minutes rest after 30 minutes of use.
(2) This product must not be used by children under the age of two as their eyesight is still developing. If a child of two years or older uses the product, do not wear the product more than 1 hour a day.

• RoHS

[Restricted substances Containment] Please go to the following website to inquire.

<https://www.jorjin.com/products/ar-smart-glasses/j-reality/j7ef/>



Manufacturer : JORJIN TECHNOLOGIES INC. Tel: +886-(02)-2649-0055
Address: 17F, No. 239, Sec. 1, Datong Rd., Xizhi Dist., New Taipei City 22161, Taiwan R.O.C.

JREALITY

J7EF

使用說明書



Jorjin Technologies Inc.
AR智慧眼鏡

AR智慧眼鏡 - 外型/功能圖

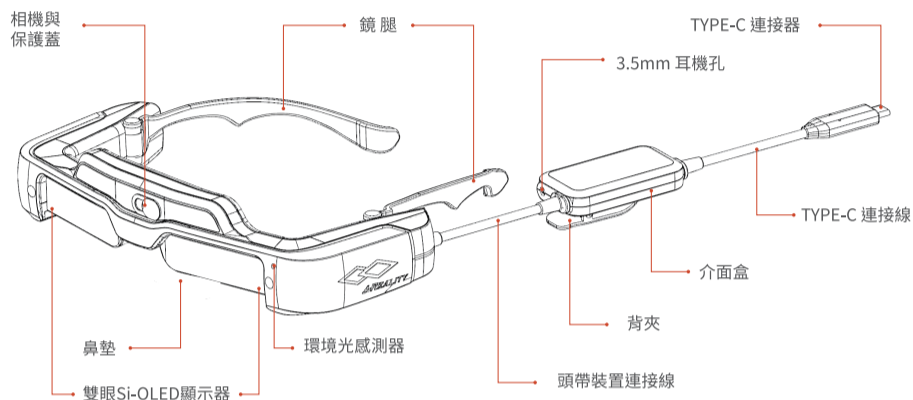

包裝內容物



TYPE C Power Cable 串接方式

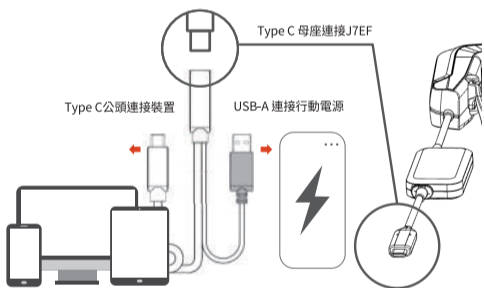

磁力計校正

如果磁力計異常時，請在連接裝置後開啟磁力傳感器相關應用工具(例：指南針)，同時以8字形移動智慧眼鏡校正。

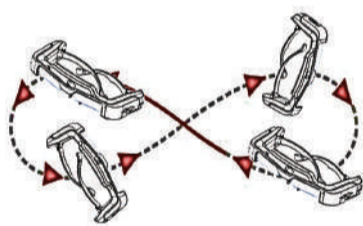

功能控制

- J-Reality Control為Android裝置的應用程式，適用於此AR智慧眼鏡之操作，包含以下功能。
 - 顯示與調整螢幕亮度及音量
 - 切換2D與3D模式，支援的3D格式為並排格式。
 - 裝置的螢幕鎖，以防止不慎操作。

- 關於功能操作之相關補充資料，請從以下連結觀看。

<https://www.jorjin.com/products/ar-smart-glasses/j-reality/j7ef/>



操作相機

- 可透USB相機應用程式，操作AR智慧眼鏡上的相機。(例：USB Camera)
- 使用時，若出現裝置本身的相機，請切換為USB相機模式。
- 佐臻JSDK適用於進行Android應用程式之開發，若有需求請洽佐臻業務人員。



使用遮光片

- 環境過於明亮時，可能影響觀看效果。可安裝隨附的遮光片，觀看螢幕。
- 遮光片具有磁性，可以直接裝上。

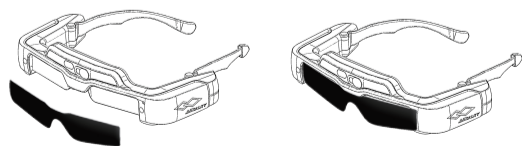

配戴鏡框

隨附鏡框為額外配件，依照使用者需求，可於一般眼鏡行由配鏡師安裝特定度數之鏡片，鏡片的成本需由客戶承擔，視配鏡師而定，配鏡師可能無法提供此服務，須諮詢眼鏡行。

| 鏡架可調式鏡片 | |
|-----------|----------|
| 鏡片(寬 x 高) | 54x24 mm |
| 鼻寬 | 20 mm |
| 鏡框PD | 70 mm |
| 曲線 | 4 |

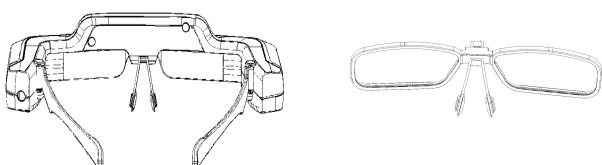

穿戴方式

雙手握住AR智慧眼鏡兩側，以大拇指將鏡腿輕輕扳開。扳開至適合頭部寬度之後，以略微傾斜角度自前額處戴入。將AR智慧眼鏡往後推至看到清楚影像為止。

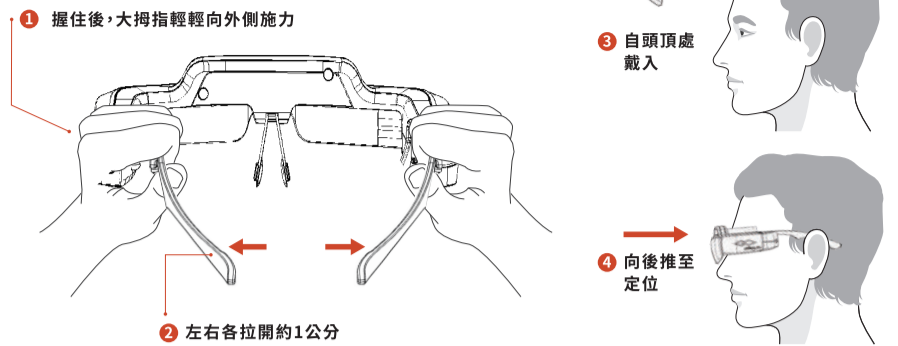

連接裝置

- 請將AR智慧眼鏡的TYPE-C連接線連接至裝置

- 連接支援USB Type-C DisplayPort Alternate Mode的裝置。
- 您需要提供自己的裝置。
- 本產品使用裝置中的電池供電，使用前請先確認裝置電量。
- 無法保證可以使用USB轉接器或轉換線，使用AR智慧眼鏡。
- 使用時請確認裝置不在睡眠模式。
- 配戴後請調整AR智慧眼鏡的位置，確保能看到影像，影像觀看效果將因人而異。

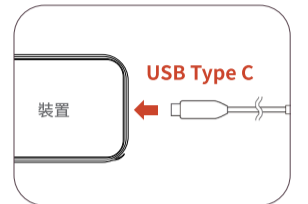

連接耳機

- 將市售耳機連接至介面盒的耳機插孔，建議使用符合CTIA標準的耳機。
- 使用3-pole耳機時，麥克風功能無法使用。
- 在播放內容時連接或拔除耳機或USB Type-C接頭，您可能會聽到一些雜音，因此請確定先取下耳機。
- 請使用裝置上的音量鍵來調整音量大小。
- 無法保證可以使用轉接器。

影音控制

- 接上支援USB Type-C DisplayPort Alternate Mode的智慧裝置，AR智慧眼鏡會顯示影像畫面。拔除TYPE-C連接線，AR智慧眼鏡將無法顯示畫面。
- 連接後若按壓裝置上的電源鍵，影像與音訊將無法作用。
- 再次按壓裝置上的電源鍵，影像與音訊將恢復運作。
- 若需暫停或離開影片播放狀態，請操作裝置。

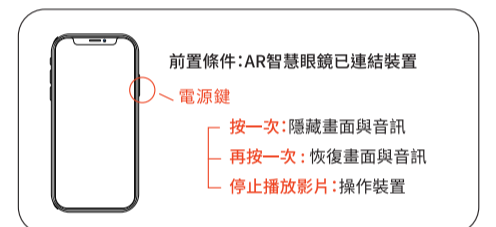
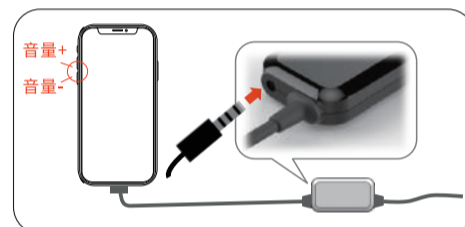

產品規格 - 型號 - J7EF

| 光學 | | |
|------------|--------------------------|-----------------------------|
| 顯示裝置類型 | Si-OLED (矽基有機發光二極體) | |
| 面板尺寸 | 0.453" 寬面板 (16:9) | |
| 解析度 | 1920x1080 | |
| 視角 | 約 34度 (對角) | |
| 虛擬螢幕尺寸 | 支援 120吋 (虛擬觀看距離5公尺) | |
| 色彩再現 | 24位元色彩 (約16,770,000色) | |
| 感應器 | | |
| 相機 | 8百萬畫素 | |
| 磁力計 | 有, 眼鏡端(頭戴式顯示器)中配備 3 軸感應器 | |
| 陀螺儀 | 有, 眼鏡端(頭戴式顯示器)中配備 3 軸感應器 | |
| 加速感測器 | 有, 眼鏡端(頭戴式顯示器)中配備 3 軸感應器 | |
| 照度感測器 | 有, 1- 65528 lux | |
| 音訊 | | |
| 音頻插孔 | 3.5 Φ 4極迷你插孔, CTIA類 | |
| 視頻輸入 | | |
| USB Type-C | 視頻介面 | DisplayPort 替代模式 (DP Alt模式) |
| | EDID | 支援 |
| 資料通訊 | | |
| USB Type-C | HDCP | 支援 |
| | USB通訊協定 | USB 2.0 |
| | 支援作業系統 | Window 10 以上版本 |
| | 支援作業系統 | Android 8 以上版本 |
| 電源 | | |
| USB Type-C | USB Type-C @1.5A | |
| | 額定耗電量 | 6W |
| | 額定電壓 / 額定電流 | 5.0V/ 1.2A |

支援格式

| 一般資料 | 3D支援 | 併列 |
|-----------|------|---------------------------|
| 頭戴顯示器外觀尺寸 | | 200 x 182 x 55 mm (不含遮光片) |
| 介面盒外觀尺寸 | | 60 x 31 x 20mm |
| 頭戴顯示器重量 | | 127g +/-15g (不含遮光片) |
| 介面盒重量 | | 45g +/-5g |
| 總線長 | | 109 cm +/- 1 cm (含介面盒) |
| 操作溫度 | | 5°C至35°C, 濕度20%至80% |
| 存放溫度 | | -10°C至60°C, 濕度20%至80% |

*本產品僅適用USB Type-C DisplayPort Alternate Mode, 但非所有符合此規格之手機皆相容, 可相容手機請見Jorjin官網說明。
*使用前請先移除保護膜

視覺落點

視覺落點五米處約有120吋，此為一般視體驗，依個人視覺感受不同。

3C視力警語

- 使用過度恐傷害視力
- (1) 使用30分鐘, 請休息10分鐘。
- (2) 2歲以下幼兒不看螢幕, 2歲以上每天看螢幕不要超過1小時。

RoHS

[限用物質含有情況] 標示內容, 請至下列網址查詢
<https://www.jorjin.com/products/ar-smart-glasses/j-reality/j7ef/>



製造商: 佐臻股份有限公司
地址: 新北市汐止區大同路一段239號17樓 電話: (02)2649-0055